

Andromeda™

MINING

WAREHOUSE

WAREHOUSE APPLICATIONS

LIGHTING IN WAREHOUSING IS DIVERSE but always critical. Whether it is low level controllable lighting for safe movement, or high intensity light for processes and workshops, the Andromeda series covers it all.

Available in powers from 30W to 300W and totally controllable, there is an Andromeda luminaire for each and every warehouse application.

BENEFITS OF OUR ANDROMEDA RANGE

- USES 50%-75% LESS ELECTRICITY THAN HIGH INTENSITY DISCHARGE LUMINAIRES
- LIFESPAN OF 50,000 HRS+ (TO L70)
- IS IP66
- IS AVAILABLE IN A VARIETY OF POWER, LENS TYPES & ARTICULATIONS FOR ANY ENVIRONMENT OR APPLICATION
- AVAILABLE WITH EMERGENCY BATTERY PACKS
- START UP AND SHUT DOWN IMMEDIATELY
- PERFECT FOR PHOTO OR MOTION SENSOR CONTROLS
- HAS LOW INRUSH & OPERATING CURRENTS
- CONTAINS NO HARMFUL, TOXIC SUBSTANCES (NO HG) & ARE RECYCLABLE
- DOES NOT EMIT UV RADIATION & DOES NOT REQUIRE UV BLOCKING FILTERS
- HAS ROBUST CONSTRUCTION, PERFECT FOR TOUGH & CHALLENGING CONDITIONS
- ELIMINATES MERCURY RECYCLING COSTS

Andromeda™ C Flood

CERAMIC LED FLOODLIGHT

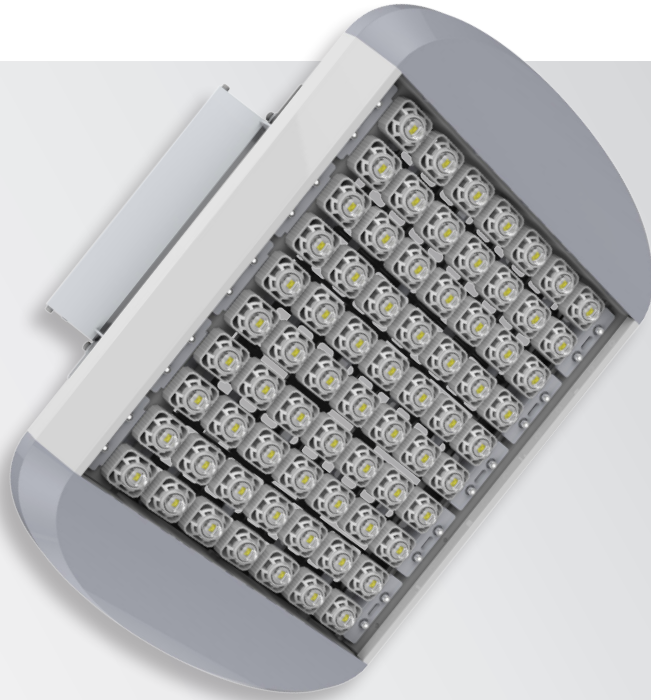

PRODUCT INFORMATION

LIGHT SOURCE	Nichia High Power LED
HOUSING	6063 Aluminium (Marine Grade) Ceramic Diode Seat with Polycarbonate Pixel Rails ST12
BRACKET MATERIAL	Wall Mount, Surface Mount, Suspended (Hook)
BRACKET TYPE	Wall Mount, Surface Mount, Suspended (Hook)
FRAME COLOUR	Silver, White, Black
MECHANICAL IMPACT RESISTANCE	IK08 (Bracket & Frame Only)
IP RATING	IP66
OPERATING TEMP	-40°C to 55°C

TECHNICAL SPECIFICATIONS

INPUT VOLTAGE	90-305VAC, 50/60Hz (Standard)
DIMMABLE	Non-dimmable standard
LIFESPAN	50,000 hours to L70
POWER	40W - 410W
POWER FACTOR	0.95
BEAM ANGLE	Distribution Ranges - Refer to lens options page
LUMINOUS EFFICACY	IESNA Type I,II,III, IV & V distribution
CCT	120 lm/W 5,000-5,500K Cool White >70 (CRI) Standard

Additional Options - Frame options 304SS & 316SS. Dimmable with 0-10V, PWM, DALI, PE Cell or Nema 7. Varying input voltage including 24V DC to 480V. CCT Options - ~4000K Natural White & ~3000K Warm White.

SCHEMATIC OF ANDROMEDA C FLOOD 140W & 165W

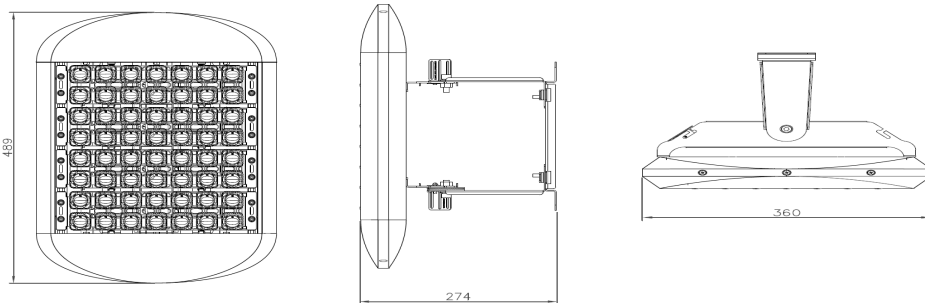

PRODUCT CODE	POWER	OUTPUT (LUMENS)	INPUT CURRENT (mA)	LENGTH (MM)	WIDTH (MM)	DEPTH (MM)	WEIGHT (KG)
Andromeda-C-Flood-40	40W	4,800	800mA	261	360	274	4.2kg
Andromeda-C-Flood-45	45W	5,400	800mA	261	360	274	4.5kg
Andromeda-C-Flood-70	70W	8,400	800mA	337	360	274	5.1kg
Andromeda-C-Flood-85	85W	10,200	800mA	337	360	274	5.5kg
Andromeda-C-Flood-110	110W	13,200	800mA	413	360	274	5.9kg
Andromeda-C-Flood-125	125W	15,000	800mA	413	360	274	6.3kg
Andromeda-C-Flood-140	140W	16,800	800mA	489	360	274	6.7kg
Andromeda-C-Flood-165	165W	19,800	800mA	489	360	274	7.2kg
Andromeda-C-Flood-180	180W	21,600	800mA	565	360	274	8.3kg
Andromeda-C-Flood-210	210W	25,200	800mA	565	360	274	8.6kg
Andromeda-C-Flood-220	220W	26,400	800mA	641	360	274	9.2kg
Andromeda-C-Flood-250	250W	30,000	800mA	641	360	274	10.4kg
Andromeda-C-Flood-280	280W	33,600	800mA	717	360	274	12.0kg
Andromeda-C-Flood-320	320W	38,400	800mA	869	360	274	14.8kg
Andromeda-C-Flood-360	360W	43,200	800mA	945	360	274	15.0kg
Andromeda-C-Flood-370	370W	44,400	800mA	869	360	274	15.3kg
Andromeda-C-Flood-410	410W	49,200	800mA	945	360	274	16.1kg

TYPICAL APPLICATIONS



Andromeda™ C Mounting Options

CERAMIC LUMINAIRES

Standard (Wall Mount)

Standard adjustable wall/ceiling mount bracket on Flood. Bracket material options - ST12, 304SS, 316SS.

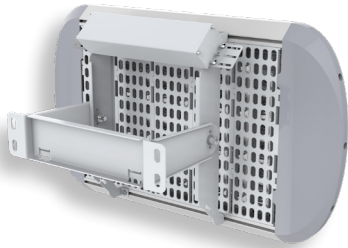

FLOOD

Canopy (Surface Mount)

Flat surface bracket for mounting directly to ceiling, stud or wall. Bracket material options - ST12, 304SS, 316SS.

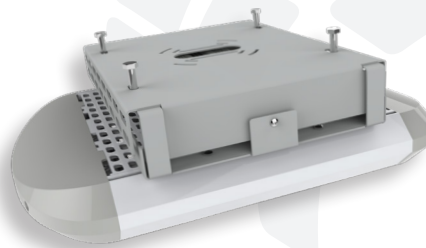

Suspension (Hooks)

Dual ST12 hooks attached to the surface bracket for suspension mounting. Bracket material options - ST12, 304SS, 316SS.

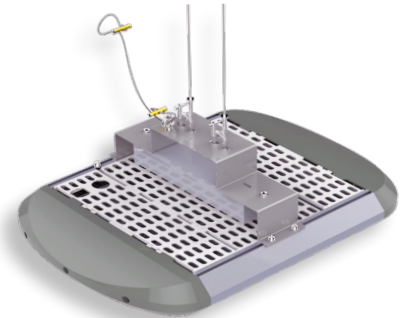

Rod Mount

Mounting bracket suitable for rod mounting with a threaded 3/4 inch pipe. Bracket material options - ST12, 304SS, 316SS.

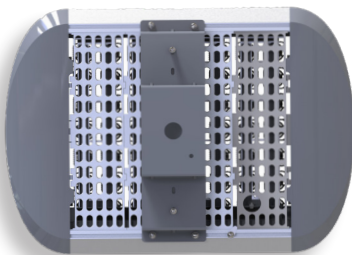

Slip Fit

Pole fitted sleeve for Andromeda Flood units. Non adjustable. 60mmOD Pole/Arm Spigot not included. Bracket material options - ST12, 304SS, 316SS.

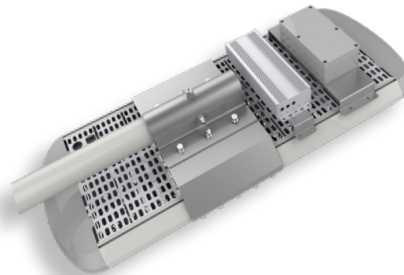

HIGH MAST

Trunnion

Heavy duty adjustable trunnion mount for High Mast luminaire. Suitable for cross beams and wall mounting. Bracket material options - ST12, 304SS & 316SS.

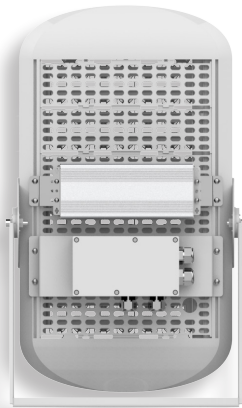

Forward Bracket

Bracket for 1000W High Mast luminaire suitable for forward throw mounting on cross beams. Bracket material options - ST12, 304SS & 316SS.

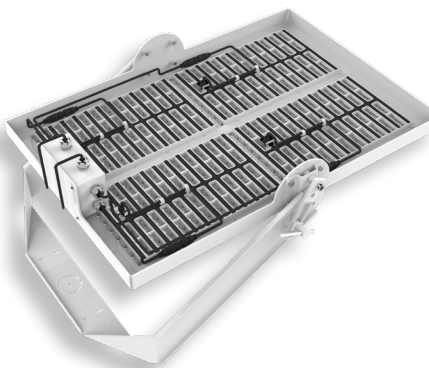

POLE MOUNT

Standard (Pole Mount)

Standard adjustable pole mount to pole diameter 60mm. Adapters available for other diameters.



SHIELD OR BLIND OPTIONS ARE AVAILABLE FOR ALL LUMINAIRES WITH ANY MOUNTING BRACKET. CONTACT EMPYREAN LIGHTING TO DISCUSS REQUIREMENTS